

REVISIONS

REV#	DESCRIPTION	APPV.	REV DATE

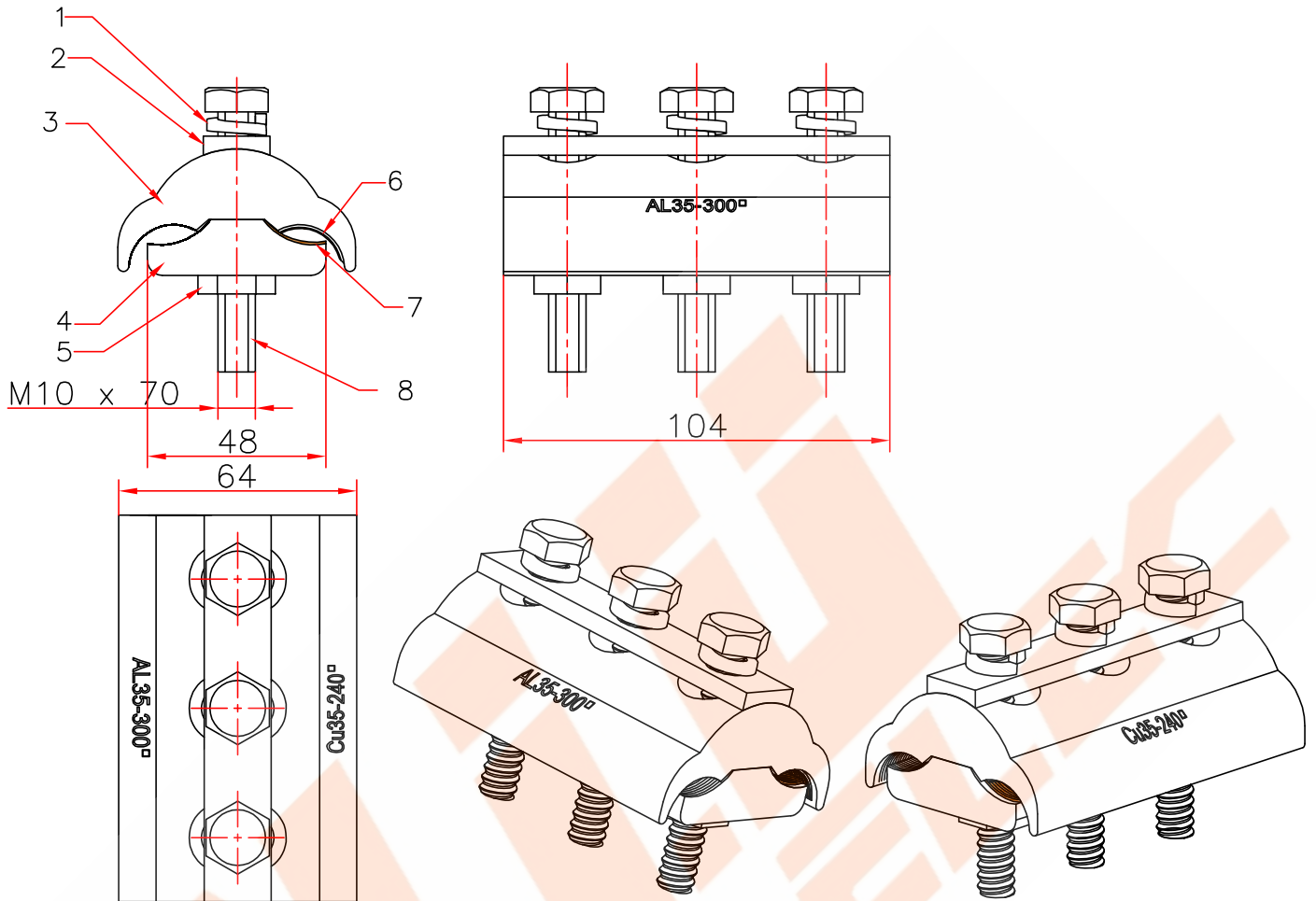

CU wire cross section :35-240 mm² AL wire cross section :35-300 mm²

8	BOLT	MILD STEEL		3
7	STRIP FOR BOTTOM CLAMP	COPPER	NATURAL & BRIGHT	1
6	STRIP FOR TOP CLAMP	COPPER	NATURAL & BRIGHT	1
5	NUT	MILD STEEL		3
4	BOTTOM BODY	ALUMINIUM ALLOY	NATURAL & BRIGHT	1
3	TOP BODY	ALUMINIUM ALLOY	NATURAL & BRIGHT	1
2	WASHER	ALUMINIUM ALLOY	NATURAL & BRIGHT	1
1	ROUDE SPRING WASHER	MILD STEEL		3
SR. NO	ITEM DESCRIPTION	MATERIAL	FINISH	QTY



N.I.U ELECTRIC GROUP CO.,LTD
 Beibaixiang Zone, Yueqing City,
 Zhejiang Province, China-325604
 Tel: +86-577-62622652
 E-mail: sales@niuelec.com

DRAWN: David

DRG No: NIU#CAPG-C
 CU35-240/AL35-300

CHECKED: